

Glue this red marked area on 0.3 mm cardboard

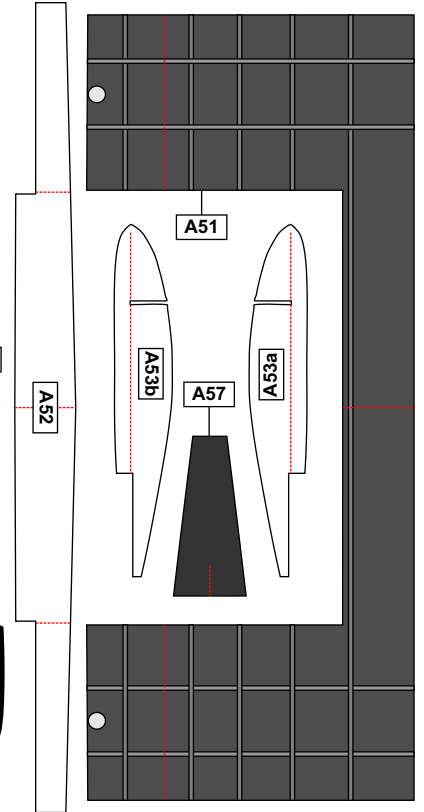

Glue this red marked area on 0.5 mm cardboard

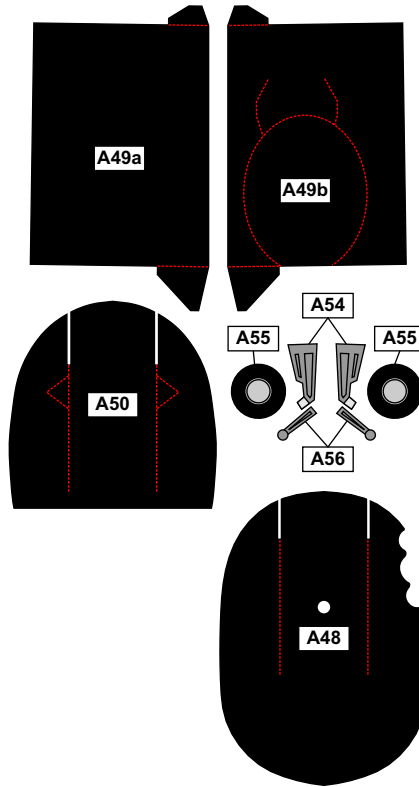
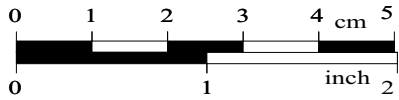
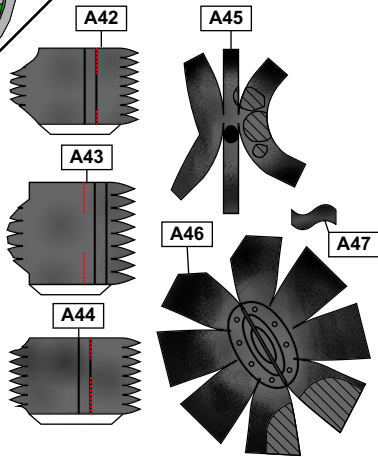
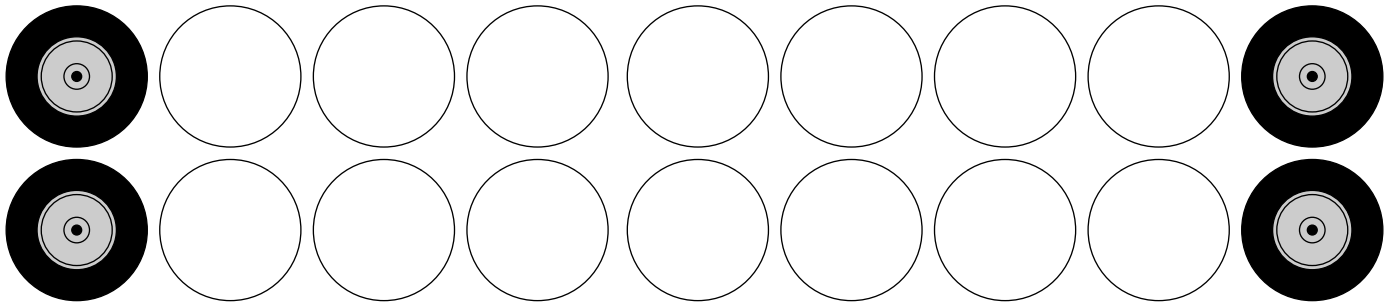
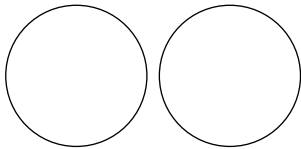
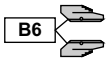

Parts for laminated wheels. (Replace elements A30)

Nose section

(Section is in scale)

